

Feed-through header - PTSM 0,5/ 3-HH-2,5-SMD WH R32 - 1708005

Please be informed that the data shown in this PDF Document is generated from our Online Catalog. Please find the complete data in the user's documentation. Our General Terms of Use for Downloads are valid (<http://phoenixcontact.com/download>)

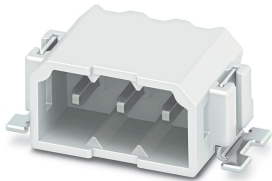

PCB header, nominal cross section: 0.5 mm², color: white, nominal current: 6 A, rated voltage (III/2): 160 V, contact surface: Tin, type of contact: Male connector, number of potentials: 3, Number of rows: 1, Number of positions per row: 3, number of connections: 3, product range: PTSM 0,5/..-HH-SMD WH, pitch: 2.5 mm, mounting: SMD soldering, pin layout: Linear pad geometry, solder pin [P]: 2 mm, plug-in system: COMBICON COMPACT PTSM, Pin connector pattern alignment: Standard, Locking: without, mounting: without, type of packaging: 32 mm wide tape, Article with anti-rotation pin

Your advantages

- ✓ White design: Stable color when welding and during use
- ✓ Designed for integration into the SMT soldering process
- ✓ Supplied in tape-on-reel packing according to IEC 60286-3 for automated mounting
- ✓ Additional solder anchors reduce the mechanical strain on the soldering spots



Key Commercial Data

Packing unit	1 pc
Minimum order quantity	600 pc
GTIN	
GTIN	4046356960649
Weight per Piece (excluding packing)	1.230 g
Custom tariff number	85366930
Country of origin	India

Technical data

Item properties

Brief article description	Feed-through header
Connector system	COMBICON COMPACT PTSM
Type of contact	Male connector
Range of articles	PTSM 0,5/..-HH-SMD WH

Feed-through header - PTSM 0,5/ 3-HH-2,5-SMD WH R32 - 1708005

Technical data

Item properties

Pitch	2.5 mm
Number of positions	3
Mounting type	SMD soldering
Pin layout	Linear pad geometry
Locking	without
Number of levels	1
Number of connections	3
Number of potentials	3
Pin connector pattern alignment	Standard

Electrical parameters

Nominal current	6 A
Nom. voltage	160 V
Rated voltage (III/3)	125 V
Rated voltage (III/2)	160 V
Rated voltage (II/2)	320 V
Rated surge voltage (III/3)	2.5 kV
Rated surge voltage (III/2)	2.5 kV
Rated surge voltage (II/2)	2.5 kV

Material data - contact

Note	WEEE/RoHS-compliant, free of whiskers according to IEC 60068-2-82/ JEDEC JESD 201
Contact material	Cu alloy
Surface characteristics	Tin-plated
Metal surface contact area (top layer)	Tin (3 - 5 μm Sn)
Metal surface contact area (middle layer)	Nickel (1.3 - 3 μm Ni)
Metal surface soldering area (top layer)	Tin (3 - 5 μm Sn)
Metal surface soldering area (middle layer)	Nickel (1.3 - 3 μm Ni)

Material data - housing

Housing color	white (9010)
Insulating material	PA
Insulating material group	I
CTI according to IEC 60112	600
Flammability rating according to UL 94	V0

Flange specifications

Type of locking	without
Mounting flange	without

Feed-through header - PTSM 0,5/ 3-HH-2,5-SMD WH R32 - 1708005

Technical data

Dimensions for the product

Caption	Schematische Abbildung - weitere Details siehe Produktfamilienzeichnung im Download Center
Length [l]	9.5 mm
Width [w]	11.3 mm
Height [h]	7 mm
Pitch	2.5 mm
Height (without solder pin)	5 mm
Solder pin [P]	2 mm
Pin spacing	2.50 mm

Dimensions for PCB design

Hole diameter	1.1 mm
Pin spacing	2.50 mm
Pad geometry	1.2 x 3.2 mm

Packaging information

Type of packaging	32 mm wide tape
Pieces per package	600
Denomination packing units	Pcs.
[W] tape width	32 mm
[A] coil diameter	330 mm
[W2] coil overall dimension	38.4 mm
Outer packaging type	Transparent-Bag
ESD level	(D) electrostatically conductive
Specification	DIN EN 61340-5-1 (VDE 0300-5-1): 2008-07

Processing notes

Process	Reflow soldering
Specification	Following IPC/JEDEC J-STD-020D.1:2008-03
	Following IEC 60068-2-58:2005-02
Moisture Sensitive Level	MSL 1
Classification temperature T _c	260 °C
Solder cycles in the reflow	3

Ambient conditions

Ambient temperature (storage/transport)	-40 °C ... 70 °C
Ambient temperature (assembly)	-5 °C ... 100 °C
Ambient temperature (operation)	-40 °C ... 100 °C (dependent on the derating curve)

Air clearances and creepage distances

Feed-through header - PTSM 0,5/ 3-HH-2,5-SMD WH R32 - 1708005

Technical data

Air clearances and creepage distances

Clearances and creepage distances	IEC 60664-1:2007-04
Specification	IEC 60664-1:2007-04
Minimum clearance - inhomogeneous field (III/3)	1.5 mm
Minimum clearance - inhomogeneous field (III/2)	1.5 mm
Minimum clearance - inhomogeneous field (II/2)	1.5 mm
Minimum creepage distance value (III/3)	1.9 mm
Minimum creepage distance value (III/2)	1.5 mm
Minimum creepage distance value (II/2)	1.6 mm

Mechanical tests (A)

Test specification	IEC 61984
Insertion strength per pos. approx.	5 N
Withdraw strength per pos. approx.	4 N
Polarization when inserted requirement >20 N	Test passed
Contact holder in insert requirements >20 N	Test passed

Durability tests (B)

Specification	IEC 60512-9-1:2010-03
Contact resistance R_1	3 m Ω
Insertion/withdrawal cycles	10
Contact resistance R_2	4 m Ω
Impulse withstand voltage at sea level	2.95 kV

Thermal tests (C)

Specification	IEC 60512-5-1:2002-02
Number of positions	8
Upper limiting temperature requirements <100 °C	Test passed

Climatic tests (D)

Specification	ISO 6988:1985-02
Cold stress	-40 °C/2 h
Thermal stress	100 °C/168 h
Corrosive stress	0.2 dm ³ SO ₂ on 300 dm ³ /40 °C/1 cycle
Impulse withstand voltage at sea level	2.95 kV
Power-frequency withstand voltage	1.39 kV

Environmental and durability tests (E)

Specification	IEC 61984:2008-10
Result, degree of protection, IP code	Back of hand safety with IP10 access probe

Feed-through header - PTSM 0,5/ 3-HH-2,5-SMD WH R32 - 1708005

Technical data

Vibration test

Specification	IEC 60068-2-6:2007-12
Frequency	10 - 150 - 10 Hz
Sweep speed	1 octave/min
Amplitude	0.35 mm (10 - 60.1 Hz)
Acceleration	5g (60.1 - 150 Hz)
Test duration per axis	2.5 h

Standards and Regulations

Connection in acc. with standard	EN-VDE
	UL
Flammability rating according to UL 94	V0

Environmental Product Compliance

China RoHS	Environmentally friendly use period: unlimited = EFUP-e
	No hazardous substances above threshold values

Drawings

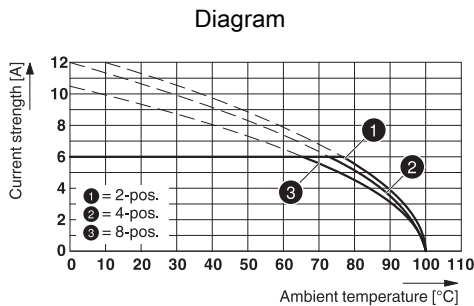

Type: PTSM 0,5/...-PL-2,5 ... with PTSM 0,5/...-HH-2,5-SMD... R...

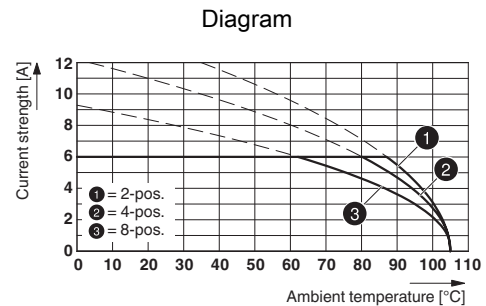

Type: PTCM 0,5/...-PL-2,5 WH with PTSM 0,5/...-HH(0)-2,5-SMD WH R...

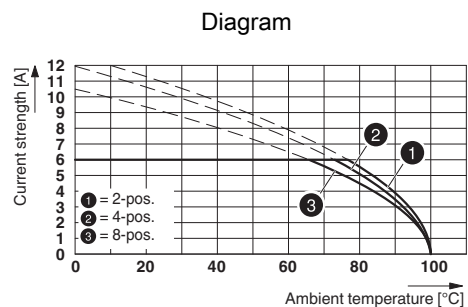
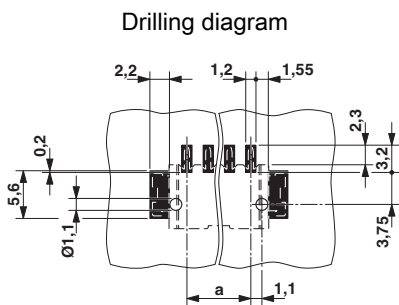

Type: PTSM 0,5/...-P-2,5 WH... with PTSM 0,5/...-HH0-2,5-SMD WH R...

Feed-through header - PTSM 0,5/ 3-HH-2,5-SMD WH R32 - 1708005

Dimensional drawing

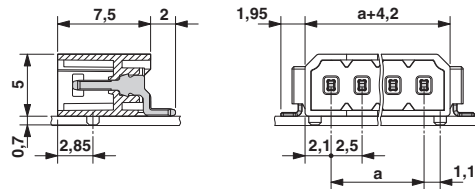

Classifications

eCl@ss

eCl@ss 10.0.1	27440402
eCl@ss 11.0	27460201
eCl@ss 4.0	27260700
eCl@ss 4.1	27260700
eCl@ss 5.0	27260700
eCl@ss 5.1	27260700
eCl@ss 6.0	27260700
eCl@ss 7.0	27440402
eCl@ss 9.0	27440402

ETIM

ETIM 4.0	EC002637
ETIM 6.0	EC002637
ETIM 7.0	EC002637

UNSPSC

UNSPSC 13.2	39121409
UNSPSC 18.0	39121409
UNSPSC 19.0	39121409
UNSPSC 20.0	39121409
UNSPSC 21.0	39121409

Approvals

Approvals

Approvals

VDE Zeichengenehmigung / UL Recognized / EAC / cULus Recognized

Feed-through header - PTSM 0,5/ 3-HH-2,5-SMD WH R32 - 1708005

Approvals

Ex Approvals

Approval details

VDE Zeichengenehmigung		http://www2.vde.com/de/Institut/Online-Service/VDE-gepruefteProdukte/Seiten/Online-Suche.aspx	40048497
Nominal voltage UN	160 V		
Nominal current IN	6 A		
mm ² /AWG/kcmil	0.14-.5		

UL Recognized		http://database.ul.com/cgi-bin/XYV/template/LISEXT/1FRAME/index.htm	E118976-20130619
	B		
Nominal voltage UN	150 V		
Nominal current IN	5 A		

EAC			B.01687
-----	---	--	---------

cULus Recognized		http://database.ul.com/cgi-bin/XYV/template/LISEXT/1FRAME/index.htm	E60425-20110108
	B		
Nominal voltage UN	150 V		
Nominal current IN	6 A		

Accessories

Additional products

Feed-through header - PTSM 0,5/ 3-HH-2,5-SMD WH R32 - 1708005

Accessories

Sample set - SAMPLE PTSM 0,5/ 3-HH-2,5-SMD - 1786057



PCB header, nominal cross section: 0.5 mm², color: black, nominal current: 6 A, rated voltage (III/2): 160 V, contact surface: Tin, type of contact: Male connector, number of potentials: 3, Number of rows: 1, Number of positions per row: 3, number of connections: 3, product range: PTSM 0,5/..-HH-SMD, pitch: 2.5 mm, mounting: SMD soldering, pin layout: Linear pad geometry, solder pin [P]: 2 mm, plug-in system: COMBICON COMPACT PTSM, Pin connector pattern alignment: Standard, Locking: without, mounting: without, type of packaging: packed in cardboard, Article with anti-rotation pin

Printed-circuit board connector - PTSM 0,5/ 3-P-2,5 WH - 1704854



PCB connector, nominal cross section: 0.5 mm², color: white, nominal current: 6 A, rated voltage (III/2): 160 V, contact surface: Tin, type of contact: Female connector, number of potentials: 3, Number of rows: 1, Number of positions per row: 3, number of connections: 3, product range: PTSM 0,5/..-P WH, pitch: 2.5 mm, connection method: Push-in spring connection, conductor/PCB connection direction: 0 °, plug-in system: COMBICON COMPACT PTSM, Locking: without, mounting: without, type of packaging: packed in cardboard

Feed-through header - PTSM 0,5/ 3-HHI-2,5-SMD WHR44 - 1707992



PCB header, nominal cross section: 0.5 mm², color: white, nominal current: 6 A, rated voltage (III/2): 160 V, contact surface: Tin, type of contact: Female connector, number of potentials: 3, Number of rows: 1, Number of positions per row: 3, number of connections: 3, product range: PTSM 0,5/..-HHI-SMD WH, pitch: 2.5 mm, mounting: SMD soldering, pin layout: Linear pad geometry, solder pin [P]: 2 mm, plug-in system: COMBICON COMPACT PTSM, Pin connector pattern alignment: Standard, Locking: without, mounting: without, type of packaging: 44 mm wide tape, Article with anti-rotation pin

Feed-through header - PTSM 0,5/ 3-HHI0-2,5-SMD WHR44 - 1815206



PCB header, nominal cross section: 0.5 mm², color: white, nominal current: 6 A, rated voltage (III/2): 160 V, contact surface: Tin, type of contact: Female connector, number of potentials: 3, Number of rows: 1, Number of positions per row: 3, number of connections: 3, product range: PTSM 0,5/..-HHI-SMD WH, pitch: 2.5 mm, mounting: SMD soldering, pin layout: Linear pad geometry, solder pin [P]: 2.1 mm, plug-in system: COMBICON COMPACT PTSM, Pin connector pattern alignment: Standard, Locking: without, mounting: without, type of packaging: 44 mm wide tape

Feed-through header - PTSM 0,5/ 3-HHI-2,5-THR WH R32 - 1814993



PCB header, nominal cross section: 0.5 mm², color: white, nominal current: 6 A, rated voltage (III/2): 160 V, contact surface: Tin, type of contact: Female connector, number of potentials: 3, Number of rows: 1, Number of positions per row: 3, number of connections: 3, product range: PTSM 0,5/..-HHI-THR WH, pitch: 2.5 mm, mounting: THR soldering, pin layout: Linear pinning, solder pin [P]: 2.1 mm, plug-in system: COMBICON COMPACT PTSM, Pin connector pattern alignment: Standard, Locking: without, mounting: without, type of packaging: 32 mm wide tape

Feed-through header - PTSM 0,5/ 3-HH-2,5-SMD WH R32 - 1708005

Accessories

Printed-circuit board connector - PTSM 0,5/ 3-PL-2,5 WH - 1709459



PCB connector, nominal cross section: 0.5 mm², color: white, nominal current: 6 A, rated voltage (III/2): 160 V, contact surface: Tin, type of contact: Female connector, number of potentials: 3, Number of rows: 1, Number of positions per row: 3, number of connections: 3, product range: PTSM 0,5/..-PL WH, pitch: 2.5 mm, connection method: Push-in spring connection, conductor/PCB connection direction: 0 °, plug-in system: COMBICON COMPACT PTSM, Locking: Snap-in locking, mounting: Self-locking flange, type of packaging: packed in cardboard